Model 4800 Series

VW Earth Pressure Cells

Instruction Manual



WARRANTY STATEMENT

GEOKON warrants its products to be free of defects in materials and workmanship, under normal use and service for a period of 13 months from date of purchase. If the unit should malfunction, it must be returned to the factory for evaluation, freight prepaid. Upon examination by GEOKON, if the unit is found to be defective, it will be repaired or replaced at no charge. However, the **WARRANTY IS VOID** if the unit shows evidence of having been tampered with or shows evidence of being damaged as a result of excessive corrosion or current, heat, moisture or vibration, improper specification, misapplication, misuse or other operating conditions outside of GEOKON's control. Components that wear or are damaged by misuse are not warranted. This includes fuses and batteries.

GEOKON manufactures scientific instruments whose misuse is potentially dangerous. The instruments are intended to be installed and used only by qualified personnel. There are no warranties except as stated herein. There are no other warranties, expressed or implied, including but not limited to the implied warranties of merchantability and of fitness for a particular purpose. GEOKON is not responsible for any damages or losses caused to other equipment, whether direct, indirect, incidental, special or consequential which the purchaser may experience as a result of the installation or use of the product. The buyer's sole remedy for any breach of this agreement by GEOKON or any breach of any warranty by GEOKON shall not exceed the purchase price paid by the purchaser to GEOKON for the unit or units, or equipment directly affected by such breach. Under no circumstances will GEOKON reimburse the claimant for loss incurred in removing and/or reinstalling equipment.

Every precaution for accuracy has been taken in the preparation of manuals and/or software, however, GEOKON neither assumes responsibility for any omissions or errors that may appear nor assumes liability for any damages or losses that result from the use of the products in accordance with the information contained in the manual or software.

No part of this instruction manual may be reproduced, by any means, without the written consent of GEOKON. The information contained herein is believed to be accurate and reliable. However, GEOKON assumes no responsibility for errors, omissions or misinterpretation. The information herein is subject to change without notification.

The GEOKON® wordmark and logo are registered trademarks with the United States Patent and Trademark Office.

TABLE OF CONTENTS

1. INTRODUCTION	1
1.1 THEORY OF OPERATION	1
1.2 EARTH PRESSURE CELL DESIGN	2
1.3 EARTH PRESSURE CELL CONSTRUCTION	3
1.3.1 MODEL 4800 EARTH PRESSURE CELLS	3
1.3.2 MODEL 4810 CONTACT ("FAT BACK") PRESSURE CELL	4
1.3.3 MODEL 4815 HYDRAULIC LOAD CELL	4
1.3.4 MODEL 4820 EARTH PRESSURE "JACKOUT" CELL	5
1.3.5 MODEL 4830 PUSH-IN PRESSURE CELL	5
2. INSTALLATION	6
2.1 PRELIMINARY TESTS	6
2.2 PRESSURE CELL INSTALLATION	6
2.2.1 INSIDE FILLS AND EMBANKMENTS	6
2.2.2 INSTALLATION OF MODEL 4810 CONTACT ("FAT BACK") PRESSURE CELL	8
2.2.3 INSTALLATION OF MODEL 4815 HYDRAULIC LOAD CELL	10
2.2.4 INSTALLATION OF MODEL 4820 JACKOUT PRESSURE CELL IN SLURRY TRENCHES	10
2.2.5 INSTALLATION OF CELLS TO MEASURE EARTH PRESSURE AT THE BASE OF FOOTINGS, FLOOR SLABS, PAVEMENTS, ETC.	11
2.2.6 INSTALLATION OF PUSH-IN PRESSURE CELLS TO MEASURE LATERAL EARTH PRESSURES	12
2.3 CABLE INSTALLATION AND SPLICING	13
2.4 ELECTRICAL NOISE	14
2.5 INITIAL READINGS	14
3. TAKING READINGS	15
3.1 OPERATING THE GK-404	15
3.2 GK-405 VIBRATING WIRE READOUT	15
3.2.1 CONNECTING SENSORS WITH 10-PIN BULKHEAD CONNECTORS ATTACHED	16
3.2.2 CONNECTING SENSORS WITH BARE LEADS	16
3.2.3 OPERATING THE GK-405	16
3.3 MEASURING TEMPERATURES	16
4. DATA REDUCTION	17
4.1 PRESSURE CALCULATION	17
4.2 TEMPERATURE CORRECTION	18
4.3 BAROMETRIC CORRECTION	18
5. TROUBLESHOOTING	20
APPENDIX A. SPECIFICATIONS	21

A.1 EARTH PRESSURE CELLS	21
A.2 STANDARD TEMPERATURE THERMISTOR	21
APPENDIX B. THERMISTOR TEMPERATURE DERIVATION	22
APPENDIX C. TEMPERATURE EFFECT ON EARTH PRESSURE AND CONCRETE STRESS CELLS	23
C.1 FORMULAS	23
C.2 EXAMPLES	25
APPENDIX D. IMPROVING CALCULATED PRESSURE ACCURACY	27

FIGURES

FIGURE 1: STRESS REDISTRIBUTION, WEAK SOIL WITH STIFF CELL	1
FIGURE 2: STRESS REDISTRIBUTION, STRONG SOIL WITH STIFF CELL	2
FIGURE 3: STRESS REDISTRIBUTION, STIFF SOIL WITH WEAK CELL	2
FIGURE 4: MODEL 4800 RECTANGULAR EARTH PRESSURE CELL	3
FIGURE 5: MODEL 4800 CIRCULAR EARTH PRESSURE CELL	3
FIGURE 6: MODEL 4810 CONTACT PRESSURE CELL	4
FIGURE 7: MODEL 4815 HYDRAULIC LOAD CELL	4
FIGURE 8: MODEL 4820 JACKOUT LOAD CELL	5
FIGURE 9: MODEL 4830 PUSH-IN PRESSURE CELL	5
FIGURE 10: MODEL 4800 EARTH PRESSURE CELL INSTALLATION	7
FIGURE 11: ATTACHMENT OF MODEL 4810 TO CONCRETE FORM	9
FIGURE 12: MODEL 4810 CONTACT PRESSURE CELL INSTALLATION	9
FIGURE 13: MODEL 4815 HYDRAULIC LOAD CELL MEASURING LOADS	10
FIGURE 14: MODEL 4820 JACKOUT PRESSURE CELL INSTALLATION	11
FIGURE 15: MODEL 4800-1-1P EARTH PRESSURE CELL INSTALLATION	12
FIGURE 16: GK-404 READOUT	15
FIGURE 17: LEMO CONNECTOR TO GK-404	15
FIGURE 18: GK-405 READOUT	15
FIGURE 19: SAMPLE MODEL 4800 CALIBRATION SHEET	19
FIGURE 20: RADIUS (R) AND THICKNESS (D)	23

TABLES

TABLE 1: RATIOS FOR TWO GROUT MIXES.....	8
TABLE 2: 4830 WIRING CHART.....	13
TABLE 3: ENGINEERING UNITS MULTIPLICATION FACTORS.....	17
TABLE 4: EARTH PRESSURE CELL SPECIFICATIONS.....	21
TABLE 5: 3KΩ THERMISTOR RESISTANCE.....	22
TABLE 6: TYPICAL VALUES OF VARIOUS CELL PARAMETERS.....	25

EQUATIONS

EQUATION 1: TERZAGHI'S PRINCIPLE OF EFFECTIVE STRESS	1
EQUATION 2: DIGITS CALCULATION	17
EQUATION 3: CONVERT DIGITS TO PRESSURE	17
EQUATION 4: TEMPERATURE CORRECTION	18
EQUATION 5: 3KΩ THERMISTOR RESISTANCE	22
EQUATION 6: EXPANSION OF LIQUID FOR A 1° C TEMPERATURE RISE	23
EQUATION 7: COMPRESSION OF LIQUID	23
EQUATION 8: EXPANSION OF LIQUID	23
EQUATION 9: DEFORMATION AT THE CENTER	23
EQUATION 10: DEFORMATION AT THE EDGE	24
EQUATION 11: DIFFERENCE IN DEFORMATION	24
EQUATION 12: AVERAGE TOTAL EXPANSION OF THE CELL	24
EQUATION 13: COMBINED EQUATIONS	24
EQUATION 14: TOTAL EMBEDMENT	24
EQUATION 15: TOTAL EMBEDMENT FOR CONTACT PRESSURE CELLS	24
EQUATION 16: PRESSURE CALCULATION WITH SECOND ORDER POLYNOMIAL ..	27
EQUATION 17: "LINEARITY (%F.S.)" ON CALIBRATION SHEET	27
EQUATION 18: CALCULATING C USING THE ZERO PRESSURE READING	27

1. INTRODUCTION

1.1 THEORY OF OPERATION

Earth Pressure Cells, sometimes called Total Pressure Cells or Total Stress Cells are designed to measure stresses in soil or the pressure of soil on structures. Cells will respond not only to soil pressures but also to ground water pressures or to pore water pressure, hence the term **total** pressure or **total** stress. A simultaneous measurement of pore water pressure (μ), using a piezometer, is necessary to separate the effective stress (σ') from the total stress (σ) as defined by Terzaghi's principle of effective stress:

$$\sigma' = \sigma - \mu$$

EQUATION 1: Terzaghi's Principle of Effective Stress

These parameters coupled with the soil strength characteristics will determine soil behavior under loads.

Earth pressure cells of the type described here are the hydraulic type; two flat plates are welded together at their periphery and are separated by a small gap filled with a hydraulic fluid. The earth pressure acts to squeeze the two plates together thus building up a pressure inside the fluid. If the plates are flexible enough (i.e., if they are thin enough relative to their lateral extent), then at the center of the plate the supporting effect of the welded periphery is negligible, and it can be stated that at the center of the cell the external soil pressure is exactly balanced by the internal fluid pressure.

This is true only if the deflection of the plates is kept to a minimum and thus it is important that the cell be stiff. This in a practical sense means that the fluid inside the cell should be as incompressible as possible and that the pressure transducer required to measure the fluid pressure should also be stiff having very little volume change under increasing pressure.

Tests conducted by various researchers (as reported by Dunicliff, 1988) have shown that the introduction of a flat stress cell into a soil mass will alter the stress field in a way dependent on the relative stiffness of the cell, with respect to the soil, and also with respect to the aspect ratio of the cell, i.e., the ratio of the width of the cell to its thickness. A thick cell will alter the stress more than a thin cell. For these reasons, a thin, stiff cell is best, and studies have shown an aspect ratio of at least 20 to 1 to be desirable.

Ideally, the cell ought to be as stiff (compressible) as the soil, but in practice this is difficult to achieve. If the cell is stiffer (less compressible) than the soil, then it will over register the soil pressure because of a zone of soil immediately around the cell which is "sheltered" by the cell and therefore does not experience the full soil pressure. This can be represented schematically as shown in Figure 1.

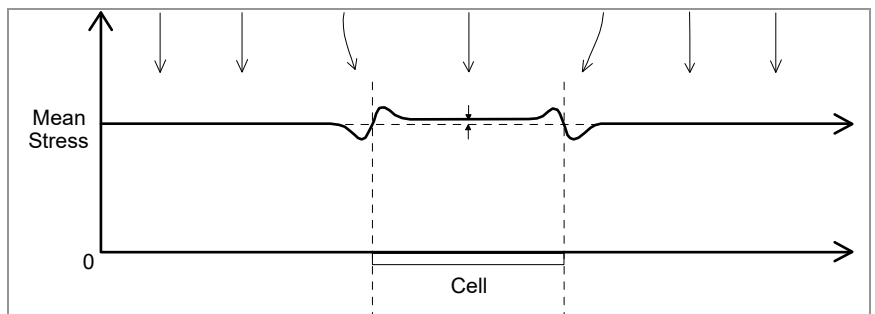

FIGURE 1: Stress Redistribution, Weak Soil with Stiff Cell

As can be seen there is a stress concentration at the rigid rim but in the center of the cell the soil stress is only slightly higher than the mean soil stress, i.e., only slightly higher than the stress which would obtain were the cell not present.

In a stronger soil, the distressed zone around the edge of the cell is more extensive; therefore, the degree of over registration of the mean stress is greater at the center of the cell. This is represented schematically in Figure 2.

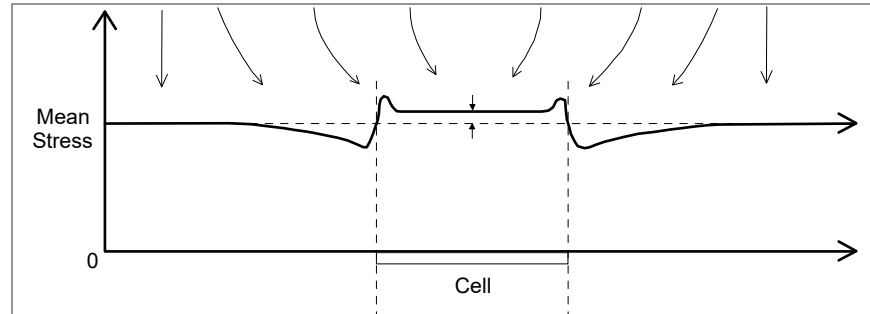

FIGURE 2: Stress Redistribution, Strong Soil with Stiff Cell

In a stiff soil the cell may be less stiff (more compressible) than the soil, in which case the cell will under register the mean soil stress as the stresses in the soil tend to "bridge" around the cell. This is represented schematically in Figure 3.

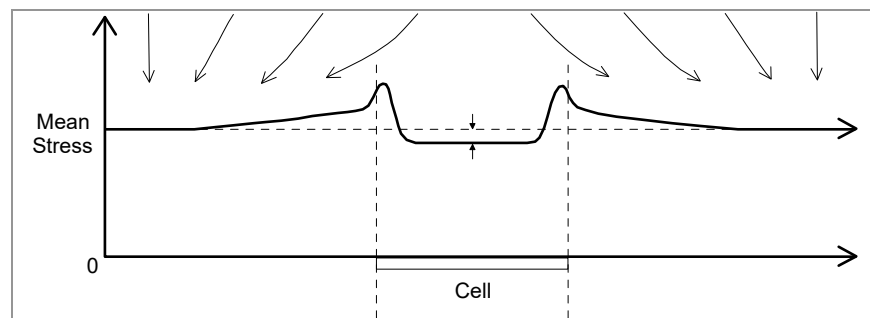

FIGURE 3: Stress Redistribution, Stiff Soil with Weak Cell

Tests conducted at the University of Ohio (USA) with several different soil types have shown that for GEOKON cells the maximum degree of over or under registration amounts to 15% of the mean soil stress.

Other factors should be kept in mind. The inherent variability of soil properties, which give rise to varying soil stresses at different locations, and a corresponding difficulty in getting a good sample of the mean stress from a limited number of cell locations. In addition, the response of the cell to its immediate surroundings depends mostly on how closely the soil mass immediately around the cell has the same stiffness or compressibility or the same degree of compaction as the undisturbed soil mass. **Installation methods will need to pay particular attention to this detail.**

1.2 EARTH PRESSURE CELL DESIGN

Earth Pressure Cells are constructed from two stainless steel plates welded together around the periphery to leave a narrow space between them. This space is filled with de-aired hydraulic oil, which is connected hydraulically to a pressure transducer. The pressure transducer converts the oil pressure into an electrical signal, which is transmitted through a signal cable to the readout location.

In general, GEOKON Earth Pressure Cells use an all welded construction; this means the space confining the oil is entirely metal and does not require any o-

rings, which tend to trap air and reduce the cell stiffness. The oil is de-aired using a Nold DeAerator, which materially improves the fluid stiffness and the performance of the cell. The pressure transducer normally employed is the GEOKON Model 4500H, which is available in several different pressure ranges (see Appendix A). The cable is attached to the transducer in a sealed, waterproof manner. For earth pressure cells located inside a soil mass, the cable may be armored and provided with strain relief at the cell to reduce the likelihood of pullout.

Located inside the vibrating wire pressure transducer housing is a thermistor for the measurement of temperature at the cell location. In addition, a tripolar plasma surge arrester inside the transducer housing protects the vibrating wire pluck and read coils from electrical transients such as may be induced by direct or indirect lightning strikes.

Alternative pressure transducers with voltage (0-100 mV, 0-5 VDC, 0-10 VDC) or current (4 - 20 mA) output are also available for dynamic readout capability. Consult the factory for additional information.

1.3 EARTH PRESSURE CELL CONSTRUCTION

1.3.1 MODEL 4800 EARTH PRESSURE CELLS

Model 4800 Earth Pressure Cells may be rectangular or circular in shape. The standard size for the rectangular Model 4800 is 150 mm x 250 mm (6" x 10"), for the circular it is 230 mm (9") in diameter. Standard thickness for both styles is 6 mm (aspect ratio ≈ 40). For laboratory tests, smaller, thinner cells can be manufactured. Contact the factory for additional information.

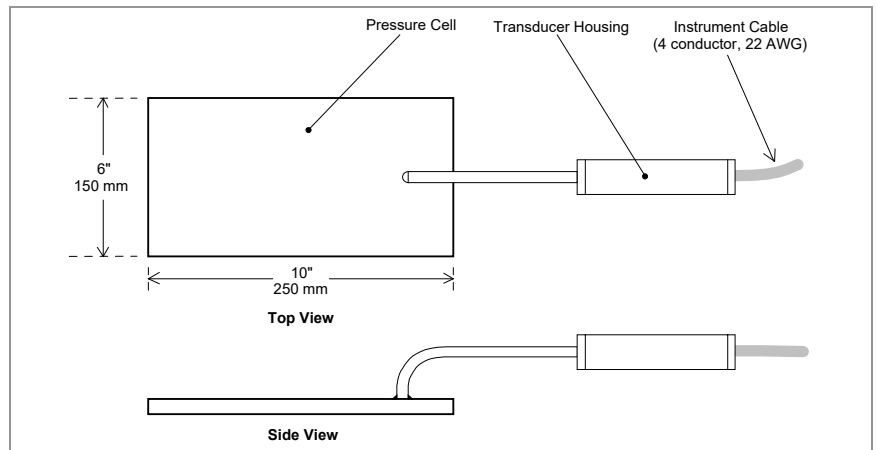

FIGURE 4: Model 4800 Rectangular Earth Pressure Cell

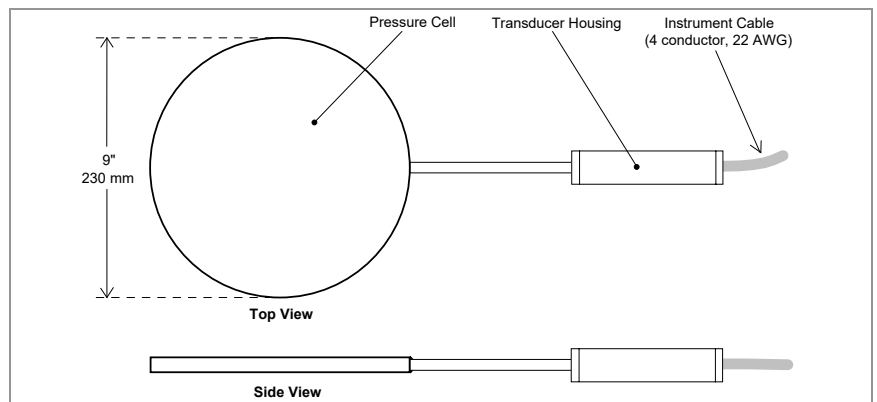

FIGURE 5: Model 4800 Circular Earth Pressure Cell

1.3.2 MODEL 4810 CONTACT ("FAT BACK") PRESSURE CELL

Model 4810 Earth Pressure Cells are designed for measuring soil pressures on structures. One of the plates is thick and designed to bear against the external surface of the structure in a way that will prevent flexure of the cell. The other plate is thin and reacts to the soil pressure.

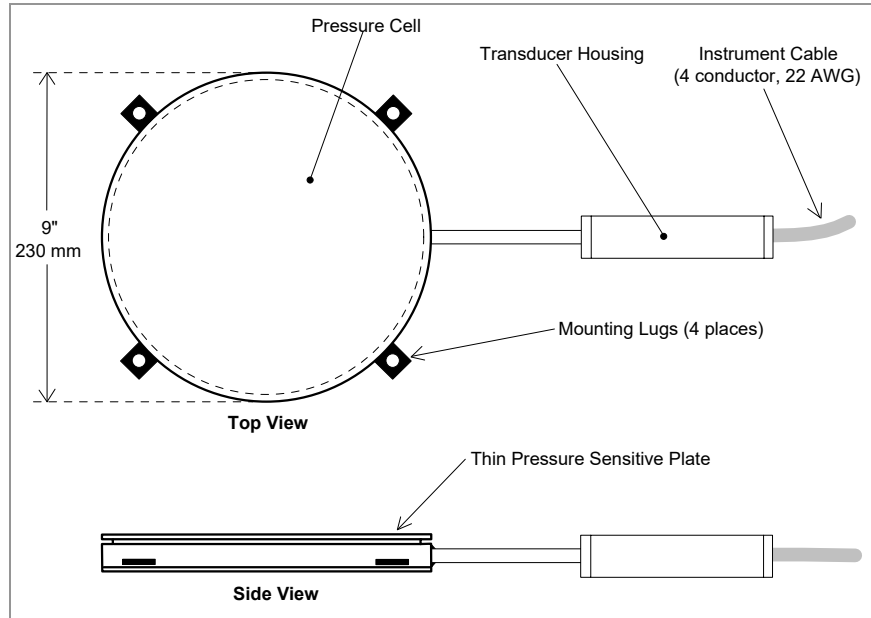

FIGURE 6: Model 4810 Contact Pressure Cell

1.3.3 MODEL 4815 HYDRAULIC LOAD CELL

Model 4815 Hydraulic Load Cell has been used for the measurement of loads in piles and of concentrated loads on tunnel linings. The pressure transducer housing is connected directly and perpendicular to the thick back plate.

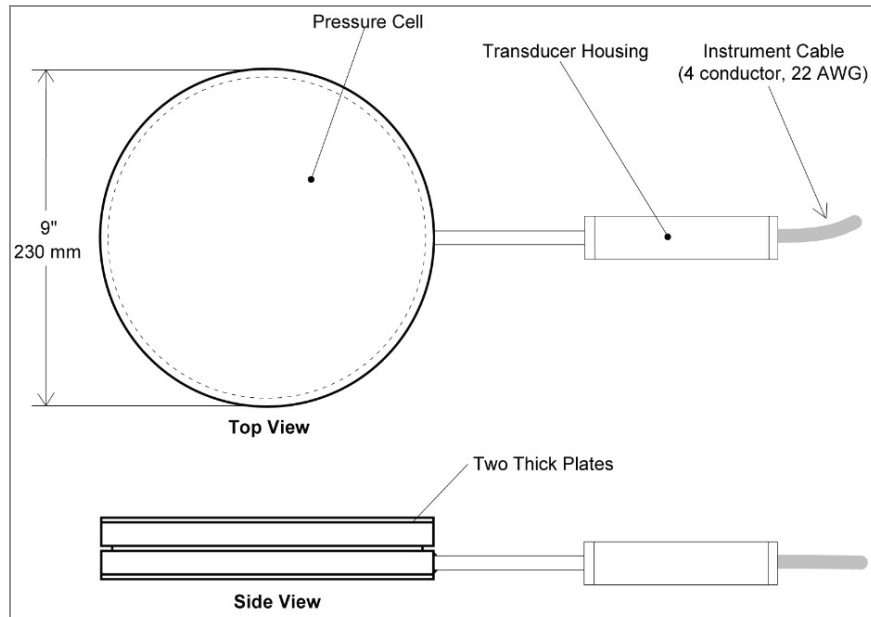

FIGURE 7: Model 4815 Hydraulic Load Cell

1.3.4 MODEL 4820 EARTH PRESSURE "JACKOUT" CELL

Model 4820 Earth Pressure Cells are designed specifically for the measurement of soil pressures on the back side of slurry walls. The pressure transducer housing is connected directly and perpendicular to the thick back plate.

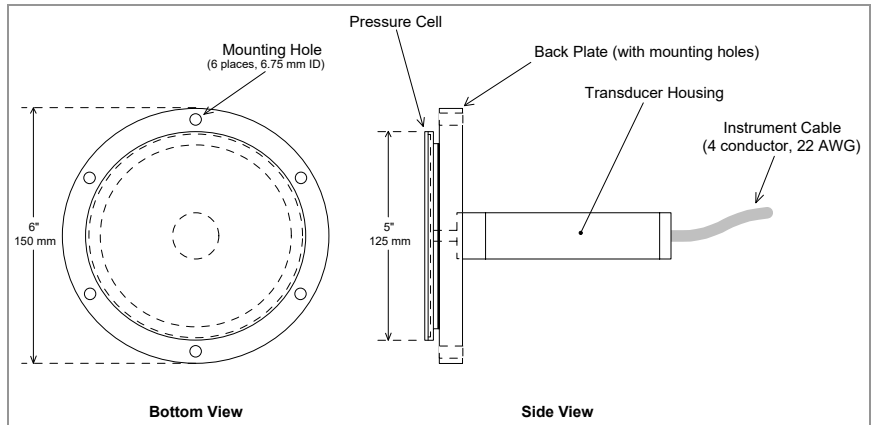

FIGURE 8: Model 4820 Jackout Pressure Cell

1.3.5 MODEL 4830 PUSH-IN PRESSURE CELL

Model 4830 Push-In Pressure Cells are designed to be pushed in place for the measurement of total pressures in soils and earth fills. The semiconductor pressure transducer enables measurement of dynamic pressures. A thread is provided on the end of the cell to allow for installation using lengths of pipe or drill rods.

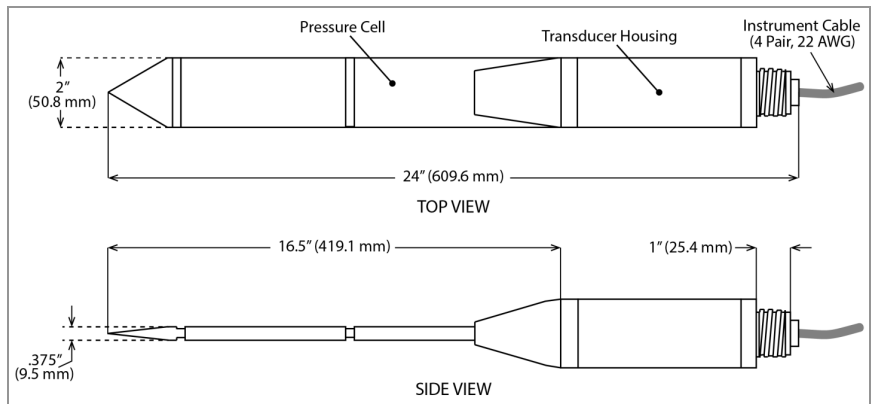

FIGURE 9: Model 4830 Push-In Pressure Cell

2. INSTALLATION

2.1 PRELIMINARY TESTS

It is always wise, before installation commences, to check the cells for proper functioning. Each cell is supplied with a calibration sheet, which shows the relationship between readout digits and pressure, as well as the initial no load zero reading. (Figure 19 in Section 4 shows a typical calibration sheet.) The cell electrical leads (usually the red and black leads) are connected to a readout box (see Section 3) and the zero reading given on the calibration sheet is compared to the current zero reading. The two readings should not differ by more than 50 digits after due regard to corrections made for different temperatures, barometric pressures and height above sea level and actual cell position (whether standing up or laying down).

By pressing on the cell, it should be possible to change the readout digits, **causing them to fall as the pressure is increased.**

Checks of electrical continuity can also be made using an ohmmeter. Resistance between the gauge leads should be approximately 180 ohms, $\pm 5\%$. Check the resistance between the two thermistor wires (usually white and green). Using Table 5 in Appendix B, convert the resistance to temperature. Compare the result to the current ambient temperature. Resistance between any conductor and the shield should exceed 20 megohms. Remember to add cable resistance when checking (22 AWG stranded copper leads are approximately 14.7Ω per 1,000 feet (48.5Ω per km), multiply by two for both directions).

2.2 PRESSURE CELL INSTALLATION

2.2.1 INSIDE FILLS AND EMBANKMENTS

Earth pressure cells are normally installed with the flat surfaces horizontal to measure vertical stresses. However, they can be placed at other orientations, inside the fill, to measure stresses in other directions e.g., a cell placed with the flat surfaces vertical will measure horizontal stresses in a direction perpendicular to the plates of the cell. They are sometimes placed at angles of 45 degrees.

Experience has shown that attempts to measure earth pressures in fills frequently meets with failure. The problem is twofold. First, the stress distribution in the fill can be inherently variable due to varying properties of the ground and varying degrees of compaction of the ground. Thus, the soil stress at one location may not be typical of the surrounding locations. Secondly, a cell installed directly in the fill could result in the creation of an anomalous zone immediately around the cell where there may be a different, more fine-grained material, under less compaction. (The material around the cell may be poorly compacted because of the need to avoid damage to the cell.)

In an earth fill, this zone of poor compaction would not be expected to be a problem since the earth above might be expected to move downwards to fill the voids and consolidate the ground. However, under the influence of rainwater and vibration, any spaces in the soil immediately around, and especially under, the cell may grow, causing the cell to become completely decoupled from the soil around it. In such situations, the internal soil stresses go around the cell instead of through it. The cell will then register only a very low pressure, which does not change much as the loads increase. This situation occurs frequently.

WEAK GROUT METHOD

One way to avoid the problem is to cast the cell inside a weak grout. A method used successfully in South Africa, by Oosthuizen et al, essentially uses the techniques similar to the one described in Section 2.2.5. Installation of the cells begins when the fill has reached a height of one meter above the instrument level. The instrument location and the cable trenches are excavated one meter deep, the instrument pocket, with 45° sloping sides (see Figure 10).

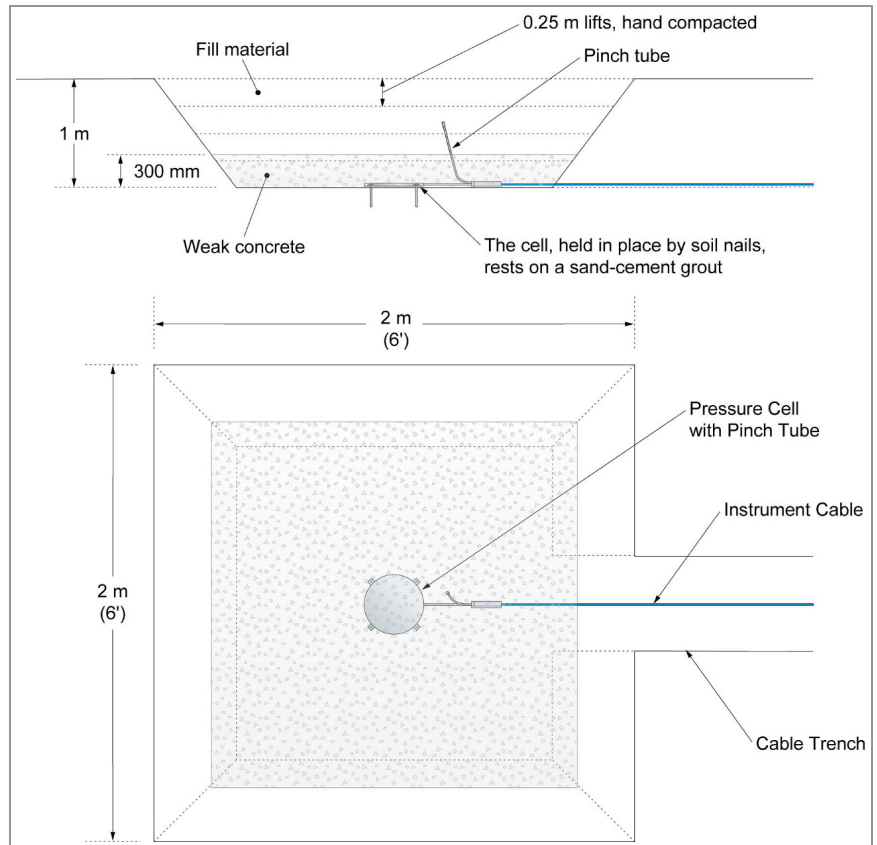

FIGURE 10: Model 4800 Earth Pressure Cell Installation

The cells (Model 4800-1-1P, complete with pinch tubes and lugs) are positioned on a thin layer of non-shrink, sand cement grout, and are nailed in position using the lugs on the cells provided for this purpose. The excavated pocket is then backfilled to a depth of 300 mm with a weak concrete in 100 mm layers, vibrated with a poker vibrator. After 24 hours, the cells are pressurized by pinching the pinch tubes until the pressure in the cell, displayed on a connected readout box, starts to change.

The instrument location containing the grouted cells and the cable trench is then backfilled in 250 mm layers, using the same material as the main fill placed by hand and compacted with pneumatic or gasoline backfill tampers, or vibratory trench rollers. After this, standard construction filling and compaction practices can continue.

Earth pressure cell clusters, placed according to the methods outlined above, may be installed either in trenches, below the temporary embankment grade, or in ramps above the temporary embankment grade. In dams, for example, it is usually convenient to install in trenches in the impervious rolled fill core, and in ramps in the filter zones and compacted rockfill shell zones. In earth embankments, it is convenient to install in trenches. By doing so, adequate

degrees of compaction of the backfill can be more easily obtained without damage to the cell clusters or cable arrays. As the cells are being covered and compacted, repeated readings should be taken to ensure that the cells are continuing to function properly.

See Section 2.3 for cable installation and protection.

Application	Grout for Medium to Hard Soils		Grout for Soft Soils	
Materials	Weight	Ratio by Weight	Weight	Ratio by Weight
Water	30 gallons	2.5	75 gallons	6.6
Portland Cement	94 lbs. (one sack)	1	94 lbs. (one sack)	1
Bentonite	25 lbs. (as required)	0.3	39 lbs. (as required)	0.4
Notes	The 28-day compressive strength of this mix is about 50 psi, similar to very stiff to hard clay. The modulus is about 10,000 psi		The 28-day strength of this mix is about 4 psi, similar to very soft clay.	

TABLE 1: Ratios for Two Grout Mixes.

ALTERNATIVE METHOD

In this method, the pressure cell used to monitor vertical earth pressures is placed directly in the fill. The procedures are similar to those in the *Weak Grout Method* section above, except that the pressure cell does not have a pinch tube and the layer of weak grout is dispensed with. Instead, the cell is placed on a pad of quick-setting mortar. This is done to ensure uniform contact with the soil at the bottom of the trench. The cell is then covered by soil placed in 300 mm layers and compacted as before.

2.2.2 INSTALLATION OF MODEL 4810 CONTACT ("FAT BACK") PRESSURE CELL

This section details installation instructions for Model 4810 earth pressure cells, which are used for the measurement of earth pressures on structures. In backfills for piers, piles, bridge abutments, retaining walls, culverts and other structures the cells may be installed either inside a concrete structure being poured or directly on the surface of an existing structure. For slurry walls, the Model 4820 earth pressure cell is used as described in Section 2.2.4.

INSTALLATION IN POURED CONCRETE

When pouring concrete, the cells can be held to the forms using nails through the lugs welded to the edge of the cell. Position the cell so that the thin pressure sensitive plate is directly against the concrete form. Nail the plates to the form lightly in such a manner that they engage the concrete sufficiently and will not pull out of the concrete when the forms are removed. Route the cable inside the concrete to a convenient readout location or to a block out inside where excess cable can be coiled. Protect the cable from damage during concrete placement and vibration by tying it to adjacent rebar. See Figure 11.

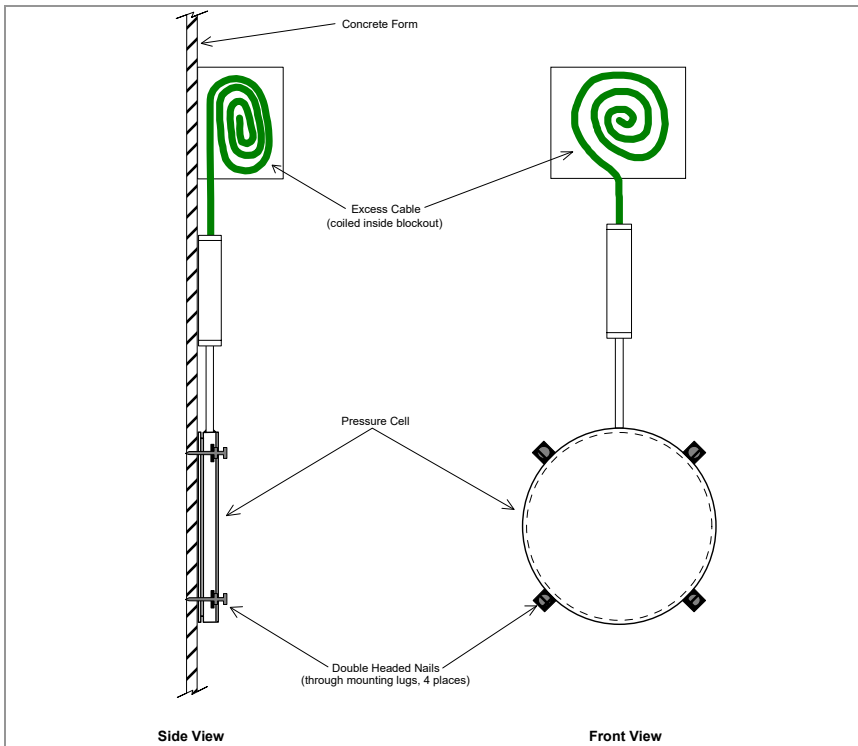

FIGURE 11: Attachment of Model 4810 to Concrete Form

INSTALLATION ON EXISTING STRUCTURES

The lugs welded to the edge of the cell can be used to hold the cell against the structure using nails, lag bolts, tie wire, etc. Even if the surface is smooth, but especially when the surface is rough or irregular, a mortar pad between the cell and the structure is required. See Figure 12 below.

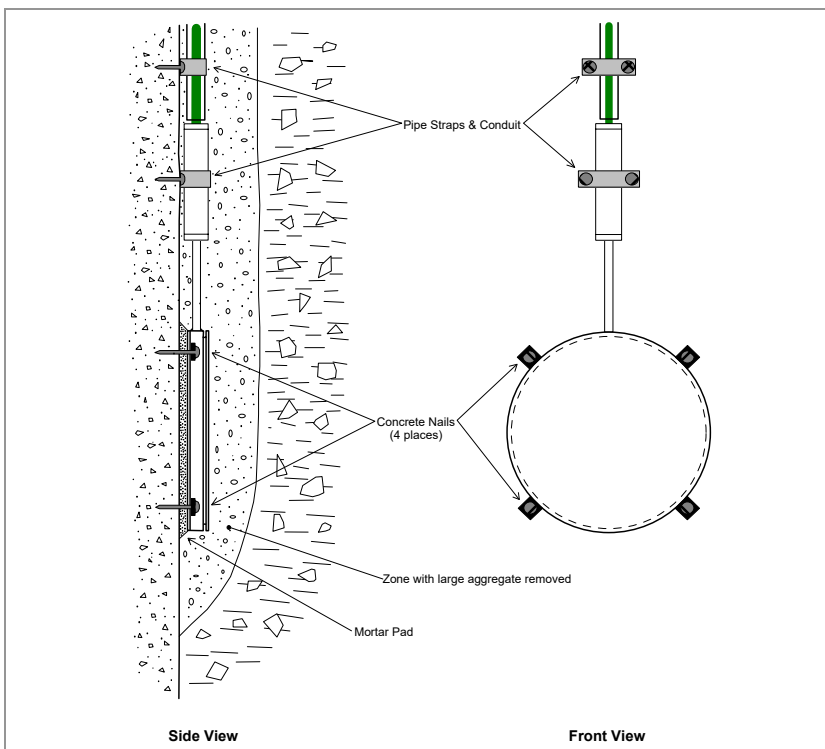

FIGURE 12: Model 4810 Contact Pressure Cell Installation

Use the lugs on the cell as a template to locate the position for drilling holes for the installation of expanding anchors or install the anchors nearby and use wire to hold the cells in place. Alternately, the cell may be nailed in place using the lugs as a guide.

Mix up some quick-setting cement mortar or epoxy cement. Trowel this onto the surface then push the cell into the cement so that the excess cement extrudes out of the edges of the cell. Hold the cell in place while the cement sets up then complete the installation by adding the lag bolts (using the expansion anchors) and tightening or nailing the cell in place. Protect the cell, transducer housing, and cable from direct contact with large chunks of rock by covering them with a fine-grained fill material from which all pieces larger than about 10 mm (0.5") have been removed. This material is kept near the cell and cable as the fill is placed. Additional cable protection can be achieved by using metal conduit strapped to the surface of the structure.

2.2.3 INSTALLATION OF MODEL 4815 HYDRAULIC LOAD CELL

A particular installation, shown in Section 13, used the Model 4815 Hydraulic Load Cell to measure the concentrated load on a tunnel lining from an existing wooden pile (supporting a building above) that had been cut short by the tunnel excavation in frozen ground. The load cell was designed to measure any increase of load on the tunnel lining that might occur when, at the end of tunnel construction, the ground was allowed to thaw out. The load cell was positioned below the bottom of the pile and temporarily held in place with lugs and a mortar pad until the shotcrete tunnel lining was sprayed.

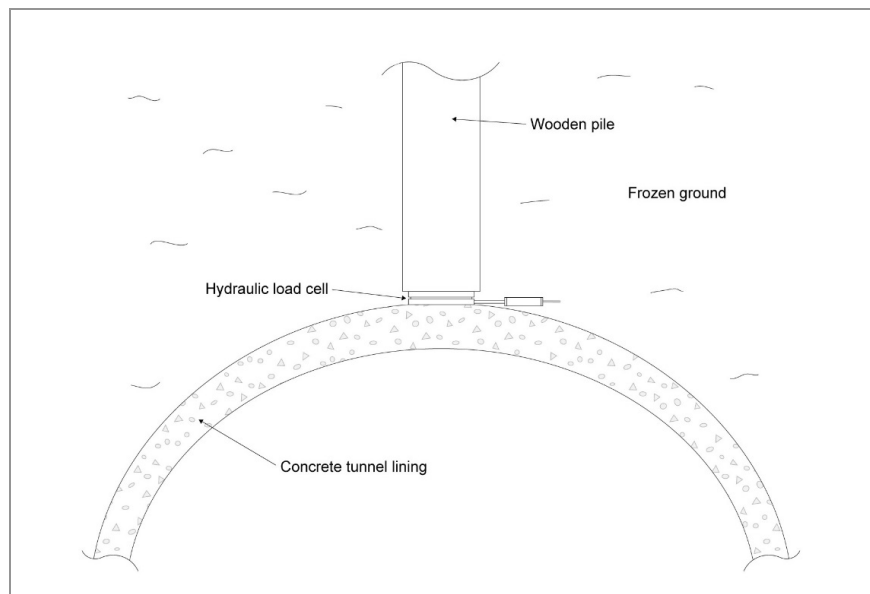

FIGURE 13: Model 4815 Hydraulic Load Cell Measuring Tunnel Lining Loads

2.2.4 INSTALLATION OF MODEL 4820 JACKOUT PRESSURE CELL IN SLURRY TRENCHES

The Jackout Pressure Cell (JOPC) first needs to be assembled into the Jackout frame (GEOKON part #4820-5 or 4820-6). The assembly is shown in Figure 14. The support plate has a circular hole cut in it and bolt holes to fit the jackout pressure cell and is connected to one end of a double-acting hydraulic jack by means of steel struts. The support plate and reaction plate are cambered top and bottom to prevent them from snagging on the sides of the slurry trench. The reaction plate is attached to the other side of the double-acting hydraulic jack. The jack is attached firmly to the rebar cable and arranged so that the plates are

free to move outwards. The hydraulic line and signal cable are tied off to one of the rebar at intervals of one meter (~ three feet).

When the rebar cage has been lowered to its proper depth, the jack is activated, forcing the two plates out against the trench walls.

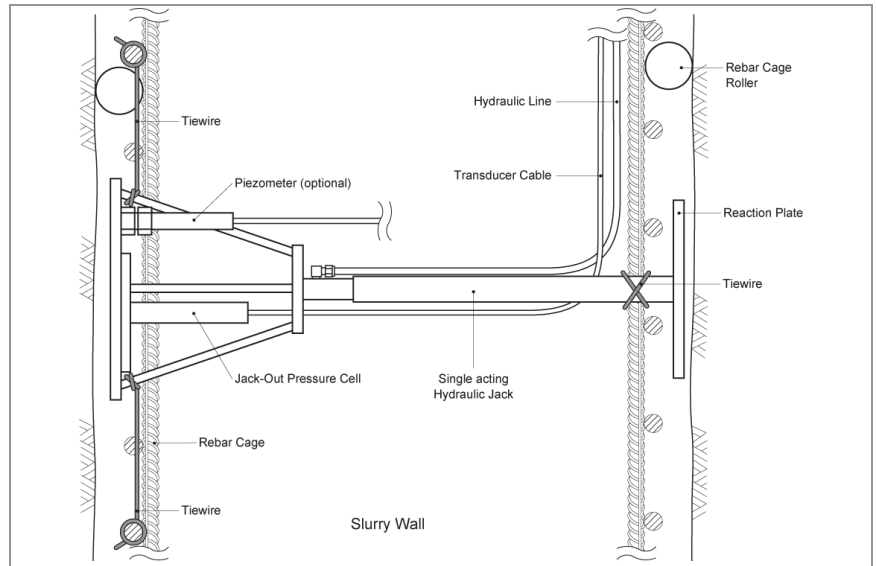

FIGURE 14: Model 4820 Jackout Pressure Cell Installation

Observation of the pressure indicated by the JOPC (see Section 3 for readout instructions) will indicate when the cell has contacted the wall. Pump up the jack until the JOPC reading indicates a pressure roughly 70 KPa (10 psi) greater than the slurry pressure at JOPC depth. This ensures that the cell is bearing against the walls of the trench, and that the concrete grout pressure will not close the jack, which could allow the reaction plates to move away from the trench walls. Check the JOPC reading from time to time, because the pressure might bleed away if the walls of the trench are soft and yielding. Repressurize as needed. Leave the jack pressurized until the grout has set up.

2.2.5 INSTALLATION OF CELLS TO MEASURE EARTH PRESSURE AT THE BASE OF FOOTINGS, FLOOR SLABS, PAVEMENTS, ETC.

Experience has shown that attempts to measure contact earth pressures on the base of footings, floor slabs, pavements, etc., frequently meets with failure. The problem is twofold. First, the contact stress distribution can be inherently variable due to varying properties of the ground and varying degrees of compaction of the ground. Thus, the contact stress at one location may not be typical of the surrounding locations. Secondly, a cell installed as described in Section 2.2.1 could result in the creation of an anomalous zone immediately around the cell where there may be a different, finer grained material, under less compaction. The material around the cell may be poorly compacted because of the need to avoid damage to the cell.

In an earth fill, this zone of poor compaction would not be a problem, since the earth above would move downwards to fill the voids and consolidate the ground. However, where there is a concrete slab immediately above the cell, this consolidation may not take place. In fact, under the influence of rainwater and vibration, the spaces around the cell may grow, causing the cell to become completely decoupled from the concrete above. In such a situation, the concrete slab bridges over the gap and the loads in the concrete go around the cell instead of through it. The cell registers only a very low pressure, which does not change as the loads increase.

The best way to avoid the problem is to cast the cell inside the concrete if possible. This can often be done when the initial concrete bonding layer is spread over the surface of the ground. At this time a Model 4800-1-1P Earth Pressure Cell with a pinch tube, is pressed into the bonding layer so that it rests against the ground below. A weighted tripod can be used to hold the stress cell in place until the concrete hardens. The pinch tube is arranged to protrude above the bonding layer and, when the concrete has hardened, it is used to pressurize the cell and ensure good contact between the cell and the surrounding concrete. See Figure 15. The advantage of this method is its simplicity and that it permits the ground below the concrete to be completely compacted in the normal way.

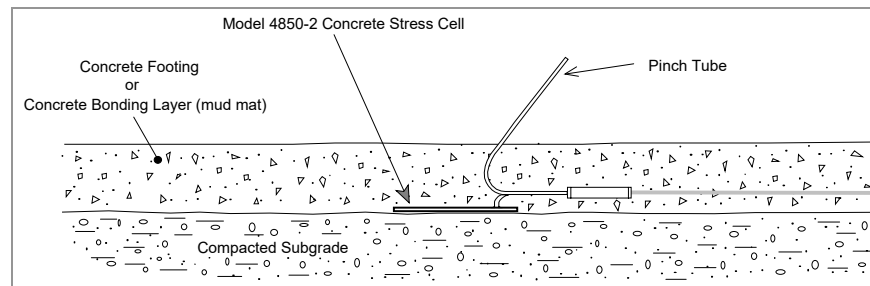

FIGURE 15: Model 4800-1-1P Earth Pressure Cell Installation

2.2.6 INSTALLATION OF PUSH-IN PRESSURE CELLS TO MEASURE LATERAL EARTH PRESSURES

The Model 4830 is designed to be pushed into soft soils using available drill rods, usually AW. Unless the ground is very soft, it is recommended that a borehole be drilled to within about two feet of the desired location, and then push the cell the rest of the way. A few things to note and be aware of include:

TEMPERATURE EFFECTS

This pressure cell is relatively stiff due to the geometry and the need for a robust construction for pushing into the ground. It is always advisable to obtain the pre-installation zero pressure readings in the borehole at the borehole temperature. It may take a significant amount of time for the sensor to come to thermal equilibrium, but this is an important measurement and if it is not possible to take this reading in the borehole, it may be possible to take the reading in a bucket of water that is at the ground temperature.

PIEZOMETER SATURATION

The piezometer filter and sensor are saturated at the factory and sealed with Mylar tape. Do not remove the tape until just before the sensor is installed in the ground. The filter is saturated by drawing a vacuum on the sensor and then allowing water to flow into the sensor when the vacuum is released. If the sensor is to be installed and then removed for use at other sites, the saturation process should be performed at each installation. GEOKON can supply the necessary portable equipment to accomplish this.

OVERPRESSURE

When pushing the cell into the ground it is possible that pressures in excess of the sensors full-scale range can be generated causing the sensor to experience a zero shift or even permanent damage. To prevent this, readings should be taken as the sensor is pushed. When the indicated pressure approaches 150% of full scale the pushing operation should be terminated until the sensor output comes back within its calibrated range.

SENSOR WIRING

4830-1 Wiring Table		4830-2 Wiring Table	
Wire Colors (GEOKON 02-250V6 Blue Cable)	Function	Wire Colors (GEOKON 04-375V9 Purple Cable)	Function
Red	Pressure Cell Sensor +	Red	Pressure Cell Sensor +
Black	Pressure Cell Sensor -	Red's Black	Pressure Cell Sensor -
White	Thermistor	White	Piezo Sensor +
Green	Thermistor	White's Black	Piezo Sensor -
Bare	Ground (Shield)	Blue	Thermistor
		Blue's Black	Thermistor
		Bare	Ground (Shield)

TABLE 2: 4830 Wiring Chart

2.3 CABLE INSTALLATION AND SPLICING

Cable placement procedures vary with individual installations. In general, however, all installations have in common the following requirements:

1. The cable must be protected from damage by angular particles of the material in which the cable is embedded.
2. The cable must be protected from damage by compaction equipment.
3. In earth and rock embankments and backfills, the cable must be protected from stretching as a result of differential compaction of the embankment.
4. In concrete structures, the cable must be protected from damage during placement and vibration of the concrete.

In embankments, cables may be embedded in a protective covering of sand or selected fine embankment materials. A typical installation might, for example, comprise the positioning of a series of cables on a prepared layer consisting of not less than 200 mm (8") of compacted selected fine material. To establish an acceptable grade without undue interference with construction operations, the prepared layer may be located either in a trench or on an exposed ramp. In rockfill dams with earth fill cores, for example, it is frequently convenient to install cable in trenches in the core and fine filter zones, and in ramps in the coarse filter and compacted rockfill shell zones. Individual cables should be spaced not less than 12 mm (0.5") apart, and no cable should be closer than 150 mm (6") to the edge of the prepared layer. In instances in which cables must cross each other, or in which more than one layer of cables must be placed in a given array, the cables should be separated from each other by a vertical interval of not less than 50 mm (2") of hand compacted sand or selected fine embankment material. Since the elongation capability of electrical cable is quite substantial, it is not necessary to install the cable with any "S" shaped meanders.

During the backfill of trenches in earth dams, a plug, approximately half a meter (two feet) in width, made of a mixture of 5% bentonite (by volume) from an approved source and exhibiting a free swell factor of approximately 600%, and 95% embankment material, can be placed in the trenches at intervals of not greater than 20 meters (50 feet). The purpose of the bentonite plugs is to reduce the possibility of water seepage through the embankment core along the backfilled trenches.

The cable may be marked by using a Mylar cable labels. For an individual cable, the identification number should be taped near the end of the cable. Additional cable labels can be specified to aid in identification if cables need to be dug up for splicing, etc.

Splice kits recommended by GEOKON incorporate casts, which are placed around the splice and are then filled with epoxy to waterproof the connections. When properly made, this type of splice is equal or superior to the cable in

strength and electrical properties. Contact GEOKON for splicing materials and additional cable splicing instructions.

Cables may be terminated by stripping and tinning the individual conductors and then connecting them to the patch cord of a readout box. Alternatively, a connector may be used which will plug directly into the readout box or to a receptacle on a special patch cord.

2.4 ELECTRICAL NOISE

Care should be exercised when installing instrument cables to keep them as far away as possible from sources of electrical interference such as power lines, generators, motors, transformers, arc welders, etc. Cables should never be buried or run with AC power lines. The instrument cables will pick up the 50 or 60 Hz (or other frequency) noise from the power cable and this will likely cause a problem obtaining a stable reading. Contact the factory concerning filtering options available for use with the GEOKON dataloggers and readouts should difficulties arise.

2.5 INITIAL READINGS

Initial readings must be taken and carefully recorded along with the barometric pressure and temperature at the time of installation. Take the initial readings while the cell is in position, prior to covering it with fill and pouring the concrete. ***Again, it is imperative that initial readings at zero load are taken!***



FIGURE 16: GK-404 Readout



FIGURE 17: Lemo Connector to GK-404



FIGURE 18: GK-405 Readout

3. TAKING READINGS

The Model GK-404 VW Readout is a portable, low-power, hand-held unit that is capable of running for more than 20 hours continuously on two AA batteries. It is designed for the readout of all GEOKON vibrating wire instruments, and is capable of displaying the reading in digits, frequency (Hz), period (μ s), or microstrain ($\mu\epsilon$). The GK-404 also displays the temperature of the transducer (embedded thermistor) with a resolution of 0.1 °C.

3.1 OPERATING THE GK-404

1. Attach the flying leads by aligning the red circle on the silver Lemo connector with the red line on the top of the GK-404 (see Figure 17). Insert the Lemo connector into the GK-404 until it locks into place.
2. Connect each of the clips on the leads to the matching colors of the sensor conductors, with blue representing the shield (bare).
3. To turn on the GK-404, press the **On/Off** button on the front panel of the unit. The initial startup screen will display.
4. After a delay, the GK-404 will start taking readings and display them based on the settings of the **Pos** and **Mode** buttons.

The unit display (from left to right) is as follows:

- The current position: set by the **Pos** button, displayed as A through F.
- The current reading: set by the **Mode** button, displayed as a numeric value followed by the unit of measure.
- Temperature reading of the attached instrument in degrees Celsius.

Use the **Pos** and **Mode** buttons to select the correct position and display units for the model of equipment purchased.

The GK-404 will continue to take measurements and display readings until the unit is turned off, either manually or by the Auto-Off timer (if enabled).

For more information, consult the GK-404 manual.

3.2 GK-405 VIBRATING WIRE READOUT

The GK-405 Readout is made up of two components:

- The Readout Unit, consisting of a Windows Mobile handheld PC running the GK-405 Vibrating Wire Readout application.
- The GK-405 Remote Module, which is housed in a weather-proof enclosure.

The remote module can be wire-connected to the sensor by means of:

- Flying leads with alligator clips if the sensor cable terminates in bare wires.
- A 10-pin connector.

The two units communicate wirelessly using Bluetooth®, a reliable digital communications protocol. Using Bluetooth, the unit can operate from the cradle of the remote module, or, if more convenient, can be removed and operated up to 20 meters away from the remote module.

The GK-405 displays the thermistor temperature in degrees Celsius.

For further details, consult the GK-405 Instruction Manual.

3.2.1 CONNECTING SENSORS WITH 10-PIN BULKHEAD CONNECTORS ATTACHED

Align the grooves on the sensor connector (male), with the appropriate connector on the readout (female connector, labeled sensor or load cell). Push the connector into place, and then twist the outer ring of the male connector until it locks into place.

3.2.2 CONNECTING SENSORS WITH BARE LEADS

Attach the flying leads to the bare leads of a GEOKON vibrating wire sensor by connecting each of the clips on the leads to the matching colors of the sensor conductors, with blue representing the shield (bare).

3.2.3 OPERATING THE GK-405

Press the power button on the Readout Unit. After start-up completes, a blue light will begin flashing, signifying that the two components are ready to connect wirelessly. Launch the GK-405 VWRA program by doing the following:

1. Tap Start on the hand-held PC's main window.
2. Select Programs.
3. Tap the GK-405 VWRA icon.

After a few seconds, the blue light should stop flashing and remain lit. The Live Readings window will display on the hand-held PC.

Set the Display mode to position B.

For more information, consult the GK-405 Instruction Manual.

3.3 MEASURING TEMPERATURES

All GEOKON vibrating wire instruments are equipped with a thermistor for reading temperature. The thermistor gives a varying resistance output as the temperature changes. The white and green leads of the instrument cable are normally connected to the internal thermistor.

The GK-404 and GK-405 readouts will read the thermistor and display the temperature in degrees Celsius.

TO READ TEMPERATURES USING AN OHMMETER:

1. Connect an ohmmeter to the green and white thermistor leads coming from the instrument. Since the resistance changes with temperature are large, the effect of cable resistance is usually insignificant. For long cables a correction can be applied equal to approximately 48.5Ω per km (14.7Ω per 1000') at 20 °C. Multiply these factors by two to account for both directions.
2. Look up the temperature for the measured resistance in Appendix B.

4. DATA REDUCTION

4.1 PRESSURE CALCULATION

The digits displayed by the GEOKON Models GK-404, GK-405, and GK-406 readouts on channel B are based on the equation:

$$\text{digits} = \left(\frac{1}{\text{Period}} \right)^2 \times 10^{-3} \quad \text{or} \quad \text{digits} = \frac{\text{Hz}^2}{1000}$$

EQUATION 2: Digits Calculation

Note that in the above equation, the period is in seconds; GEOKON readout boxes display microseconds. For example, a reading of 8000 digits corresponds to a period of 354 μs and a frequency of 2828 Hz.

Digits are directly proportional to the applied pressure, as can be seen by the following equation:

$$\text{Pressure} = (\text{Current Reading} - \text{Initial Zero Reading}) \times \text{Linear Calibration Factor}$$

Or

$$P = (R_1 - R_0) \times G$$

EQUATION 3: Convert Digits to Pressure

The Initial Reading (R_0) is normally obtained during installation (usually the zero reading). The Calibration Factor (G , usually in terms of psi or kPa per digit) comes from the supplied Calibration Sheet (a typical calibration sheet is shown in Figure 18). To convert the output to other engineering units, multiply the Calibration Factor by the conversion multiplier listed in Table 3.

From To	psi	"H ₂ O	'H ₂ O	mm H ₂ O	m H ₂ O	"HG	mm HG	atm	mbar	bar	kPa	MPa
psi	1	.036127	.43275	.0014223	1.4223	.49116	.019337	14.696	.014503	14.5039	.14503	145.03
"H ₂ O	27.730	1	12	.039372	39.372	13.596	.53525	406.78	.40147	401.47	4.0147	4016.1
'H ₂ O	2.3108	.08333	1	.003281	3.281	1.133	.044604	33.8983	.033456	33.4558	.3346	334.6
mm H ₂ O	704.32	25.399	304.788	1	1000	345.32	13.595	10332	10.197	10197	101.97	101970
m H ₂ O	.70432	.025399	.304788	.001	1	.34532	.013595	10.332	.010197	10.197	.10197	101.97
"HG	2.036	.073552	.882624	.0028959	2.8959	1	.03937	29.920	.029529	29.529	.2953	295.3
mm HG	51.706	1.8683	22.4196	.073558	73.558	25.4	1	760	.75008	750.08	7.5008	7500.8
atm	.06805	.002458	.029499	.0000968	.0968	.03342	.001315	1	.000986	.98692	.009869	9.869
mbar	68.947	2.4908	29.8896	.098068	98.068	33.863	1.3332	1013.2	1	1000	10	10000
bar	.068947	.002490	.029889	.0000981	.098068	.033863	.001333	1.0132	.001	1	.01	10
kPa	6.8947	.24908	2.98896	.0098068	9.8068	3.3863	1.3332	101.320	.1	100	1	1000
MPa	.006895	.000249	.002988	.0000098	.009807	.003386	.000133	.101320	.0001	.1	.001	1

TABLE 3: Engineering Units Multiplication Factors

For example, assume an initial reading of $R_0 = 9101$, a present reading of, $R_1 = 7390$ and a Calibration Factor of -0.1192 kPa/digit. The calculated pressure is:

$$204 \text{ kPa} = (7390 - 9101) \times -0.1192$$

(Appendix D shows how a second order polynomial can be used to improve accuracy.)

Note: Due to changes in specific gravity with temperature, the factors for mercury and water in the above table are approximate.

4.2 TEMPERATURE CORRECTION

The vibrating wire earth pressure cell is quite sensitive to temperature fluctuations but often temperature changes in the ground are minor and can be ignored. Corrections for temperature effects on the transducer alone can be made using the Thermal Factor (**K**) supplied on the calibration sheet (see Figure 18) along with an equation for its proper use. See Equation 4.

The temperature correction equation is as follows:

Temperature Correction = (Current Temperature – Initial Zero Temperature) × Thermal Factor

Or

$$P_{\text{corrected}} = (R_1 - R_0) G + (T_1 - T_0) K$$

EQUATION 4: Temperature Correction

The calculated correction would then be added to the pressure calculated using Equation 3. If the engineering units were converted, remember to apply the same conversion to the calculated temperature correction.

For example, assume an initial temperature of 25 °C, a temperature at the time of measurement of 12 °C and a Thermal Factor of +0.03852 kPa / °C. The thermally corrected pressure is:

$$203.5 \text{ kPa} = 204 + (12 - 25) \times 0.03852$$

Note that this correction for temperature applies only to the pressure transducer, not to the entire cell surrounded by soil or soil and concrete each with its own (different) temperature coefficient of expansion. Commercially it is not practical to measure this effect without incurring huge expenses. The effect is usually small at depths where the temperature is rather constant, but where temperatures do vary the effect can be quite large. For more information see Appendix D which gives a theoretical treatment.

In practice, the best way to compensate for temperatures is to derive a factor from simultaneous measurements of pressure and temperature at times when the temperature is changing and when it can be safely assumed that the applied load is not changing.

4.3 BAROMETRIC CORRECTION

The pressure transducer used in GEOKON vibrating wire earth pressure cells is evacuated and hermetically sealed and will respond to barometric pressure fluctuation. If a correction for these fluctuations is required, then it is necessary to record the initial barometric pressure (S_0) and the barometric pressure at the time of each reading (S_1) and subtract the change ($S_1 - S_0$) from the calculated pressure reading.



48 Spencer St. Lebanon, NH 03766 USA

Vibrating Wire Pressure Transducer Calibration Report

Model Number: 4500INS-350 kPa

Date of Calibration: September 20, 2011

Serial Number: 1124847

Temperature: 22.8 °C

Barometric Pressure: 999.1 mbar

Technician: *Steven Kennedy*

Applied Pressure (kPa)	Gage Reading 1st Cycle	Gage Reading 2nd Cycle	Average Gage Reading	Calculated Pressure (Linear)	Error Linear (%FS)	Calculated Pressure (Polynomial)	Error Polynomial (%FS)
0.0	8980	8981	8981	0.298	0.09	-0.059	-0.02
70.0	8395	8395	8395	70.06	0.02	70.13	0.04
140.0	7811	7811	7811	139.7	-0.10	139.9	-0.02
210.0	7223	7223	7223	209.7	-0.08	210.0	0.00
280.0	6634	6634	6634	279.9	-0.03	280.0	-0.01
350.0	6042	6043	6043	350.4	0.11	350.0	0.01

(kPa) Linear Gage Factor (G): -0.1192 (kPa/ digit)

Regression Zero: 8983

Polynomial Gage factors:

A: -3.082E-07

B: -0.1145

C: _____

Thermal Factor (K): 0.03852 (kPa/ °C)

Calculate C by setting P=0 and R_1 = initial field zero reading into the polynomial equation

(psi) Linear Gage Factor (G): -0.01728 (psi/ digit)

Polynomial Gage Factors:

A: -4.47E-08

B: -0.01661

C: _____

Thermal Factor (K): 0.005586 (psi/ °C)

Calculate C by setting P=0 and R_1 = initial field zero reading into the polynomial equation

Calculated Pressures:

$$\text{Linear, } P = G(R_1 - R_0) + K(T_1 - T_0) - (S_1 - S_0)^2$$

$$\text{Polynomial, } P = AR_1^2 + BR_1 + C + K(T_1 - T_0) - (S_1 - S_0)^2$$

*Barometric pressures expressed in kPa or psi. Barometric compensation is not required with vented transducers.

The above instrument was found to be in tolerance in all operating ranges.
The above named instrument has been calibrated by comparison with standards traceable to the NIST, in compliance with ANSI Z540-1.

This report shall not be reproduced except in full without written permission of Geokon Inc.

FIGURE 19: Sample Model 4800 Calibration Sheet

5. TROUBLESHOOTING

Maintenance and troubleshooting is confined to periodic checks of cable connections and maintenance of terminals. Once installed, these instruments are usually inaccessible and remedial action is limited. Should difficulties arise, consult the following list of problems and possible solutions. Return any faulty gauges to the factory. **Instruments should not be opened in the field.** For additional troubleshooting and support, contact GEOKON.

SYMPTOM: THERMISTOR RESISTANCE IS TOO HIGH

- Check for an open circuit. Check all connections, terminals, and plugs. If a cut is located in the cable, splice according to instructions in .

SYMPTOM: THERMISTOR RESISTANCE IS TOO LOW

- Check for a short circuit. Check all connections, terminals, and plugs. If a short is located in the cable, splice according to instructions in .
- Water may have penetrated the interior of the instrument. There is no remedial action.

SYMPTOM: INSTRUMENT READINGS ARE UNSTABLE

- Is the readout box position set correctly? If using a datalogger to record readings automatically, are the swept frequency excitation settings correct?
- Is there a source of electrical noise nearby? Likely candidates are generators, motors, arc welding equipment, high voltage lines, etc. If possible, move the instrument cable away from power lines and electrical equipment or install electronic filtering.
- Make sure the shield drain wire is connected to ground. Connect the shield drain wire to the readout using the blue clip.
- Does the readout or datalogger work with another instrument? If not, it may have a low battery or possibly be malfunctioning.

SYMPTOM: INSTRUMENT FAILS TO READ

- Does the readout or datalogger work with another instrument? If not, it may have a low battery or possibly be malfunctioning.
- Is the cable cut or crushed? Check the resistance of the cable by connecting an ohmmeter to the sensor leads; resistance is approximately 48.5Ω per km (14.7Ω per 1000') of 22 AWG wire.
- If the resistance is very high or infinite, the cable is probably broken. If the resistance is very low, the conductors may be shorted. If a break or a short is present, splice according to the instructions in Section 2.3.
- Does the readout or datalogger work with another pressure cell? If not, the readout or datalogger may be malfunctioning. Consult the readout or datalogger manual for further direction.

Refer to the expected resistance for the various wire combinations below.

Vibrating Wire Sensor Lead Resistance Levels

Red/Black $\cong 180\Omega$

Green/White 3000 at 25 °C

Any other wire combination will result in a measurement of infinite resistance.

APPENDIX A. SPECIFICATIONS

A.1 EARTH PRESSURE CELLS

Model:	4800 Earth Pressure Cell (rectangular)	4800 Earth Pressure Cell (circular)	4810 Contact Pressure Cell	4820 Jack-Out Pressure Cell
Ranges: ¹	70 kPa (10 psi) 170 kPa (25 psi) 350 kPa (50 psi) 700 kPa (100 psi) 1 MPa (150 psi) 2 MPa (300 psi) 3 MPa (435 psi) 5 MPa (750 psi) 7.5 MPa (1100 psi) 20 MPa (3000 psi)	70 kPa (10 psi) 170 kPa (25 psi) 350 kPa (50 psi) 700 kPa (100 psi) 1 MPa (150 psi) 2 MPa (300 psi) 3 MPa (435 psi) 5 MPa (750 psi) 7.5 MPa (1100 psi) 20 MPa (3000 psi)	350 kPa (50 psi) 700 kPa (100 psi) 1 MPa (150 psi) 2 MPa (300 psi) 3 MPa (500 psi) 5 MPa (750 psi)	350 kPa (50 psi) 700 kPa (100 psi) 1 MPa (150 psi) 2 MPa (300 psi) 3 MPa (500 psi) 5 MPa (750 psi)
Resolution:	±0.025% FSR			
Accuracy: ²	±0.5% FSR (±0.1% FSR with a polynomial expression)			
Linearity:	±0.5% FSR (standard), ±0.1% FSR (optional)			
Overrange:	1.5 x Rated Pressure			
Operating Temperature:	-20 to +80° C			
Excitation Frequency Range	1400-3500Hz			
Output Frequency Range	2000-3000Hz			
Cell Dimensions: ³ (active area)	150 × 250 mm 6 × 10"	230 mm OD 9" OD	230 mm OD 9" OD	125 mm OD 5" OD
Coil Resistance:	150 Ω			
Material:	316 Stainless Steel			
Weight:	2.3 kg. (5 lbs.)	2.3 kg. (5 lbs.)	4.7 kg. (10.3 lbs.)	2.7 kg. (6 lbs.)
Electrical Cable: ⁴	Two twisted pair (four stranded conductor), 22 AWG Foil shield (with drain wire), PVC jacket, nominal OD=6.3 mm (0.250")			

TABLE 4: Earth Pressure Cell Specifications

Notes:

- ¹ Consult the factory for other ranges available
- ² The stated accuracy is the accuracy of the pressure transducer. The total system accuracy depends on many factors, as discussed in Section 1.1.
- ³ Consult the factory for other sizes available.
- ⁴ Consult the factory for alternate cable types.

A.2 STANDARD TEMPERATURE THERMISTOR

Range: -80 to +150° C

Accuracy: ±0.5° C

APPENDIX B. THERMISTOR TEMPERATURE DERIVATION

3KΩ THERMISTOR RESISTANCE

Thermistor Types:

- YSI 44005, Dale #1C3001-B3, Alpha #13A3001-B3
- Honeywell 192-302LET-A01

Resistance to Temperature Equation:

$$T = \frac{1}{A+B(\ln R)+C(\ln R^3)} - 273.15$$

EQUATION 5: 3kΩ Thermistor Resistance

Where:

T = Temperature in °C

LnR = Natural Log of Thermistor Resistance

A = 1.4051 x 10⁻³

B = 2.369 x 10⁻⁴

C = 1.019 x 10⁻⁷

Note: Coefficients calculated over the -50 to +150 °C span.

Ohms	Temp	Ohms	Temp	Ohms	Temp	Ohms	Temp	Ohms	Temp
201.1K	-50	15.72K	-9	2221	32	474.7	73	137.2	114
187.3K	-49	14.90K	-8	2130	33	459.0	74	133.6	115
174.5K	-48	14.12K	-7	2042	34	444.0	75	130.0	116
162.7K	-47	13.39K	-6	1959	35	429.5	76	126.5	117
151.7K	-46	12.70K	-5	1880	36	415.6	77	123.2	118
141.6K	-45	12.05K	-4	1805	37	402.2	78	119.9	119
132.2K	-44	11.44K	-3	1733	38	389.3	79	116.8	120
123.5K	-43	10.86K	-2	1664	39	376.9	80	113.8	121
115.4K	-42	10.31K	-1	1598	40	364.9	81	110.8	122
107.9K	-41	9796	0	1535	41	353.4	82	107.9	123
101.0K	-40	9310	1	1475	42	342.2	83	105.2	124
94.48K	-39	8851	2	1418	43	331.5	84	102.5	125
88.46K	-38	8417	3	1363	44	321.2	85	99.9	126
82.87K	-37	8006	4	1310	45	311.3	86	97.3	127
77.66K	-36	7618	5	1260	46	301.7	87	94.9	128
72.81K	-35	7252	6	1212	47	292.4	88	92.5	129
68.30K	-34	6905	7	1167	48	283.5	89	90.2	130
64.09K	-33	6576	8	1123	49	274.9	90	87.9	131
60.17K	-32	6265	9	1081	50	266.6	91	85.7	132
56.51K	-31	5971	10	1040	51	258.6	92	83.6	133
53.10K	-30	5692	11	1002	52	250.9	93	81.6	134
49.91K	-29	5427	12	965.0	53	243.4	94	79.6	135
46.94K	-28	5177	13	929.6	54	236.2	95	77.6	136
44.16K	-27	4939	14	895.8	55	229.3	96	75.8	137
41.56K	-26	4714	15	863.3	56	222.6	97	73.9	138
39.13K	-25	4500	16	832.2	57	216.1	98	72.2	139
36.86K	-24	4297	17	802.3	58	209.8	99	70.4	140
34.73K	-23	4105	18	773.7	59	203.8	100	68.8	141
32.74K	-22	3922	19	746.3	60	197.9	101	67.1	142
30.87K	-21	3748	20	719.9	61	192.2	102	65.5	143
29.13K	-20	3583	21	694.7	62	186.8	103	64.0	144
27.49K	-19	3426	22	670.4	63	181.5	104	62.5	145
25.95K	-18	3277	23	647.1	64	176.4	105	61.1	146
24.51K	-17	3135	24	624.7	65	171.4	106	59.6	147
23.16K	-16	3000	25	603.3	66	166.7	107	58.3	148
21.89K	-15	2872	26	582.6	67	162.0	108	56.8	149
20.70K	-14	2750	27	562.8	68	157.6	109	55.6	150
19.58K	-13	2633	28	543.7	69	153.2	110		
18.52K	-12	2523	29	525.4	70	149.0	111		
17.53K	-11	2417	30	507.8	71	145.0	112		
16.60K	-10	2317	31	490.9	72	141.1	113		

TABLE 5: 3KΩ Thermistor Resistance

APPENDIX C. TEMPERATURE EFFECT ON EARTH PRESSURE AND CONCRETE STRESS CELLS

The following theoretical treatment is by no means rigorous — there are some questionable assumptions and approximations — but it should give some idea of the magnitude of the thermal effect to be expected on hydraulic earth pressure cells, buried in soil, or installed at the contact between soil and structure, and on concrete stress cells embedded in concrete.

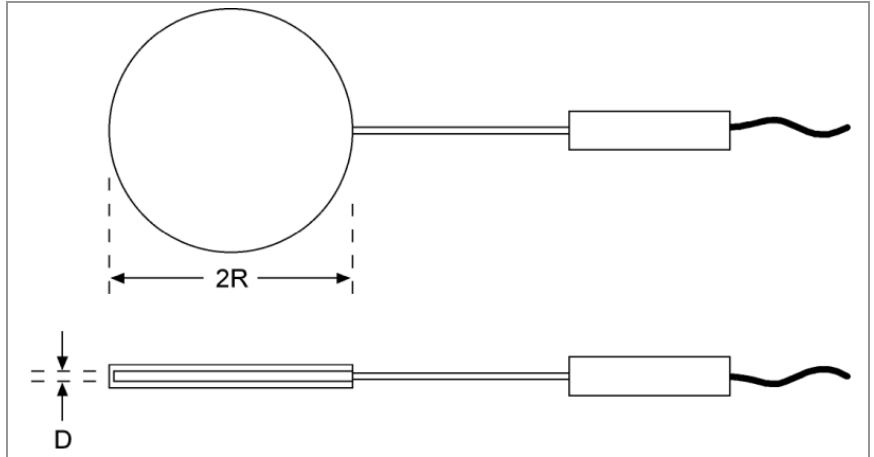

FIGURE 20: Radius (R) and Thickness (D)

C.1 FORMULAS

Consider a circular cell of radius (R) containing a liquid film of a thickness (D), coefficient of thermal expansion $K_{ppm} / ^\circ C$, and bulk modulus (G).

For a temperature rise of $1^\circ C$ the expansion (Y_T) of the liquid film is given by the equation:

$$Y_T = KD$$

EQUATION 6: Expansion of Liquid for a $1^\circ C$ Temperature Rise

Expansion of the liquid is resisted by the confinement of the surrounding medium (soil or concrete) and this causes a pressure rise (P) in the liquid, as well as a compression of the liquid (Y_c) given by the equation:

$$Y_c = PD/G$$

EQUATION 7: Compression of Liquid

The net expansion (Y) of the cell is equal to:

$$Y = D (K - P/G)$$

EQUATION 8: Expansion of Liquid

Liquid pressure inside the cell causes deformation of the surrounding medium. The amount of deformation can be quantified by modification of formula found in Equation 6, where the deformation (Y), produced by a uniform pressure (P), acting on a circular area, (R) radius, on the surface of a material with modulus of elasticity (E) and Poisson's ratio (ν), is given by:

At the center of the cell:

$$Y = \frac{2PR(1-\nu^2)}{E}$$

EQUATION 9: Deformation at the Center

At the edge of the cell:

$$Y = \frac{4PR(1-v^2)}{\pi E}$$

EQUATION 10: Deformation at the Edge

The difference being:

$$PR(1-v^2)(2-4/\pi)/E$$

EQUATION 11: Difference in Deformation

The above formulas apply to pressures acting on a free surface. However, in the confined case, Y , at the edge of the cell, can be assumed to be nearly zero.

Therefore, Y , at the center, is assumed to be the same as shown in Equation 11.

If the average Y across the cell is assumed to be half this value, and if the deformation of the medium on either side of the cell is assumed to be the same, then the average total expansion of the cell is given by:

$$Y = 0.73 PR (1 - v^2) \times 0.5 \times 2/E = 0.73 PR (1 - v^2)/E$$

EQUATION 12: Average Total Expansion of the Cell

Equating Equation 8 and Equation 12 gives:

$$P (D/G + 0.73 R (1 - v^2)/E) = KD$$

EQUATION 13: Combined Equations

If one side of the cell lies in contact with a rigid structure, e.g., a concrete retaining wall or a concrete bridge footing, then:

$$Y = 0.73 PR (1 - v^2) \times 0.5/E = 0.36 PR (1 - v^2)/E$$

and

$$P (D/G + 0.36 R (1 - v^2)/E) = KD$$

Where (E) pertains to the soil material.

Since these expressions are only approximate, they can be simplified even further:

For all $E < 10 \times 10^6$ psi the term D/G is negligible, so long as the cell is designed and constructed properly, i.e., G is large, (no air trapped inside the cell), and D is small. In addition, the term $(1 - v^2)$ can be replaced by 0.91 since v usually lies between 0.25 and 0.35.

The total embedment is given by:

$$P = 1.5 EKD/R \text{ psi} / ^\circ\text{C}$$

EQUATION 14: Total Embedment

And for contact pressure cells:

$$P = 3 EKD/R \text{ psi} / ^\circ\text{C}$$

EQUATION 15: Total Embedment for Contact Pressure Cells

Some typical values of the various parameters are:

Liquid	K x 10 ⁻⁶ / °C	G x 10 ⁶ psi
Oil	700	0.3
Mercury	180	3.6
Water	170	0.3
Glycol	650	0.26
50/50 Glycol/Water	400	0.28
Embedment Material	E x 10 ⁶ psi	v
Plastic Clay	0.003	
Soil	0.001 to 0.02 [Ref 2]	0.25 to 0.45
Sand	0.02 to 0.06 [Ref 3]	0.28 to 0.35
Compacted Ottawa Sand	0.2	
Weathered Rock	0.04 to 0.11 [Ref 4]	
Concrete	5.0	0.25

TABLE 6: Typical Values of Various Cell Parameters

C.2 EXAMPLES

For an oil-filled cell, nine inches diameter, and $D = 0.060$ inches, totally embedded in:

(For contact pressure cells, multiply the values for P by two.)

Plastic Clay:

$$E = 3000 \text{ psi}$$

$$v = 0.3$$

$$P = 0.042 \text{ psi / } ^\circ\text{C}$$

Soil, medium stiffness:

$$E = 10000 \text{ psi}$$

$$v = 0.3$$

$$P = 0.138 \text{ psi / } ^\circ\text{C}$$

Coarse Sand:

$$E = 50000 \text{ psi}$$

$$v = 0.3$$

$$P = 0.69 \text{ psi / } ^\circ\text{C}$$

For an oil-filled concrete stress cell, nine inches in diameter, and $D=0.020$ inches totally embedded in:

Concrete:

$$E = 5 \times 10^6 \text{ psi}$$

$$v = 0.25$$

$$P = 22.7 \text{ psi / } ^\circ\text{C}$$

Completely rigid medium:

$$P = 210 \text{ psi / } ^\circ\text{C}$$

For the same cell, filled with mercury instead of oil:

Concrete:

$$P = 5.8 \text{ psi / } ^\circ\text{C}$$

Completely rigid medium:

$$P = 650 \text{ psi / } ^\circ\text{C}$$

REFERENCES:

- [1] Roark, R.J. and Young, W.C. "Formulas for Stress and Strain," McGraw Hill, fifth edition, 1982, p 519.
- [2] Weiler, W.A. and Kulhawy, F.H. "Factors Affecting Stress Cell Measurement in Soil" J. Geotech. Eng. Div. ASCE. Vol. 108, No. GT12, Dec., pp1529-1548.
- [3] Lazebnik, G.E., "Monitoring of Soil-Structure Interaction." Chapman & Hall. pp 224.
- [4] Fujiyasu, Y. and Orihara, K. "Elastic Modulus of Weathered Rock." Proc. of the 5th Intl. Symp. on Field Measurements in Geomechanics - Singapore 1999. p 183.

APPENDIX D. IMPROVING CALCULATED PRESSURE ACCURACY

Most vibrating wire pressure transducers are sufficiently linear ($\pm 0.2\%$ FS) that use of the linear calibration factor satisfies normal requirements. However, it should be noted that the accuracy of the calibration data, which is dictated by the accuracy of the calibration apparatus, is always $\pm 0.1\%$ F.S.

This level of accuracy can be recaptured, even where the transducer is nonlinear, using a second order polynomial expression, which gives a better fit to the data than does a straight line. The polynomial expression has the form:

$$\text{Pressure} = AR^2 + BR + C$$

EQUATION 16: *Pressure Calculation with Second Order Polynomial*

Where:

R is the reading (digits channel B)

A, B, and C are coefficients

Figure 19 shows a typical calibration sheet of a transducer that has a very little nonlinearity. The figure under the "Linearity (%FS)" column is:

$$\frac{\text{Calculated Pressure} - \text{True Pressure}}{\text{Full Scale Pressure}} \times 100\% = \frac{G(R_1 - R_0) - P}{\text{F.S.}} \times 100\%$$

EQUATION 17: *"Linearity (%F.S.)" on Calibration Sheet*

Note: The linearity is calculated using the regression zero for R_0 shown on the sheet.

For example, from the typical sheet shown in Figure 19:

$$P = 210 \text{ kPa}, G(R_1 - R_0) = -0.1192(7223 - 8983)$$

Gives a calculated pressure of 209.8 kPa, the error is 0.2 kPa.

Whereas the polynomial expression gives a calculated pressure of:

$$A(7223)^2 + B(7223) + 1053 = 209.9 \text{ kPa}$$

The actual error is only 0.1 kPa.

This is an insignificant improvement, however, where the nonlinearity is higher, for example $\pm 0.25\%$ F.S., the improvement could be significant.

Note: If the polynomial equation is used it is important that the value of C, in the polynomial equation, be taken in the field, following the procedures described in Section 2.5. The field value of C is calculated by inserting the initial field zero reading into the polynomial equation with the pressure, P, set to zero.

If the field zero reading is not available, calculate C using the zero pressure reading on the calibration sheet. In the above example, the value of C would be derived from the equation:

$$0 = A(8981)^2 + B(8981) \text{ from which } C = +1053$$

EQUATION 18: *Calculating C Using the Zero Pressure Reading from the Cal Sheet*

It should be noted that where changes of earth pressures are being monitored it makes little difference whether the linear coefficient or the polynomial expression is used.

GEOKON®

GEOKON
48 Spencer Street
Lebanon, New Hampshire
03766, USA

Phone: +1 (603) 448-1562
Email: info@geokon.com
Website: www.geokon.com

GEOKON
is an **ISO 9001:2015**
registered company